

Ø25, 30 LED Pilot Lamp

KR Series



CE

Part Number Description

KR - **1** **2** **3**



1 Size	25 : Ø25	30 : Ø30		
2 Supply Voltage	1 : 100 ~ 125VAC/DC	2 : 200 ~ 240VAC	3 : 380 ~ 440VAC	4 : 24VAC/DC
3 Color	R : Red	G : Green	Y : Yellow	W : White

General Specification

Current Consumption	20mA	Weight	34g
Insulation Resistance	100MΩ 500VDC	Ambient Temperature	-35°C ~ +85°C
Life Cycle	50,000 hrs	Tightening Torque	0.8N·m (8.16kgf·cm)
Lamp	LED	Life Cycles	50,000 hrs



* LED working 50% less than the original brightness after 50000 hours.

Product Selection

Size	Supply Voltage	Color	Part Number	Size	Supply Voltage	Color	Part Number
 Ø25	24VAC/DC	Red	KR254R	 Ø30	24VAC/DC	Red	KR304R
		Green	KR254G			Green	KR304G
		Yellow	KR254Y			Yellow	KR304Y
		White	KR254W			White	KR304W
	100/125VAC/DC	Red	KR251R		100/125VAC/DC	Red	KR301R
		Green	KR251G			Green	KR301G
		Yellow	KR251Y			Yellow	KR301Y
		White	KR251W			White	KR301W
	200/240VAC	Red	KR252R		200/240VAC	Red	KR302R
		Green	KR252G			Green	KR302G
		Yellow	KR252Y			Yellow	KR302Y
		White	KR252W			White	KR302W
380/440VAC	Red	KR253R	380/440VAC	Red	KR303R		
	Green	KR253G		Green	KR303G		
	Yellow	KR253Y		Yellow	KR303Y		
	White	KR253W		White	KR303W		

The exterior dimension and Panel cut out

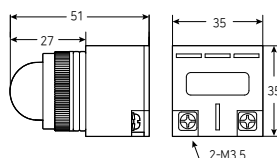
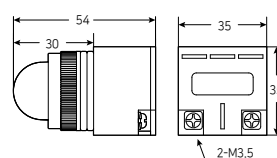
Unit : mm

KR-25	Panel Cut Out	KR-30	Panel Cut Out
			

Ø22, 25 LED Pilot Lamp

KPL Series



Part Number Description

KPL - 1 2

1 Color	R : Red	G : Green	Y : Yellow	B : Blue	W : White
2 Supply Voltage	12VAC/DC	24VAC/DC	110VAC	220VAC	110VDC

General Specification

Current Consumption	20mA
Insulation Resistance	100MΩ 500VDC
Life Cycles	50,000 hrs
Weight	24g
Ambient Temperature	-25°C ~ +55°C
Tightening Torque	0.8N·m (8.16kg·cm)

* LED working 50% less than the original brightness after 50000 hours.

Product Selection

Type	Color	Part Number	Supply Voltage
 Pilot illuminated Round lamp for Ø22,25	Red	KPL-R	12VAC/DC
	Green	KPL-G	24VAC/DC
	Yellow	KPL-Y	110VAC
	Blue	KPL-B	220VAC
	White	KPL-W	110VDC

Dimension

Unit : mm

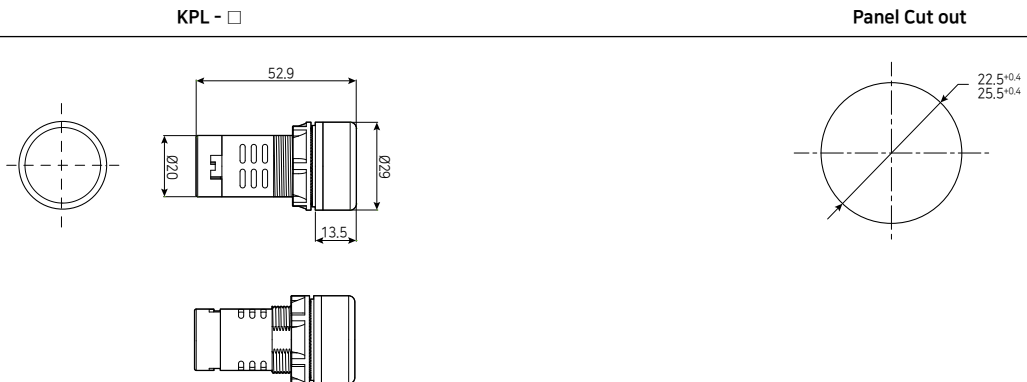

LED Signal Lamp

KL Series

Part Number Description



KL	-	1	2	3		
1 Size	06 : Ø6	08 : Ø8	10 : Ø10	12 : Ø12	14 : Ø14	16 : Ø16
2 Supply Voltage	12 : 12VAC/DC	24 : 24VAC/DC	11 : 110VAC	22 : 220VAC		
3 Color	R : Red	G : Green	Y : Yellow	B : Blue	W : White	

General Specification

Current Consumption	Max. 20mA (24VDC) / AC Max. 10mA
Dielectric Strength	500VAC for 1 minute
Insulation Resistance	Min. 100MΩ 500VDC
Material	Brass + Cr Plate
Life Cycles	50,000 hrs
Ambient Temperature	-25°C ~ +60°C





☞ All right reserved. Specification subject to change without notice.
 * LED working 50% less than the original brightness after 50000 hours.

Product Selection

Size	Supply Voltage	Color	Part Number	Size	Supply Voltage	Color	Part Number
 Ø6.0	12VAC/DC	Red	KL0612R	 Ø8.0	12VAC/DC	Red	KL0812R
		Green	KL0612G			Green	KL0812G
		Yellow	KL0612Y			Yellow	KL0812Y
		Blue	KL0612B			Blue	KL0812B
		White	KL0612W			White	KL0812W
	24VAC/DC	Red	KL0624R		Red	KL0824R	
		Green	KL0624G		Green	KL0824G	
		Yellow	KL0624Y		Yellow	KL0824Y	
		Blue	KL0624B		Blue	KL0824B	
		White	KL0624W		White	KL0824W	
110VAC	Red	KL0611R	Red	KL0811R			
	Green	KL0611G	Green	KL0811G			
	Yellow	KL0611Y	Yellow	KL0811Y			
	Blue	KL0611B	Blue	KL0811B			
	White	KL0611W	White	KL0811W			
220VAC	Red	KL0622R	Red	KL0822R			
	Green	KL0622G	Green	KL0822G			
	Yellow	KL0622Y	Yellow	KL0822Y			
	Blue	KL0622B	Blue	KL0822B			
	White	KL0622W	White	KL0822W			



Product Selection

Size	Supply Voltage	Color	Part Number	Size	Supply Voltage	Color	Part Number
	12VAC/DC	Red	KL1012R		12VAC/DC	Red	KL1412R
		Green	KL1012G			Green	KL1412G
		Yellow	KL1012Y			Yellow	KL1412Y
		Blue	KL1012B			Blue	KL1412B
Ø10.0	24VAC/DC	White	KL1012W	Ø14.0	24VAC/DC	White	KL1412W
		Red	KL1024R			Red	KL1424R
		Green	KL1024G			Green	KL1424G
		Yellow	KL1024Y			Yellow	KL1424Y
Ø10.0	110VAC	Blue	KL1024B	Ø14.0	110VAC	Blue	KL1424B
		White	KL1024W			White	KL1424W
		Red	KL1011R			Red	KL1411R
		Green	KL1011G			Green	KL1411G
Ø10.0	220VAC	Yellow	KL1011Y	Ø14.0	220VAC	Yellow	KL1411Y
		Blue	KL1011B			Blue	KL1411B
		White	KL1011W			White	KL1411W
		Red	KL1022R			Red	KL1422R
	12VAC/DC	Green	KL1022G		12VAC/DC	Green	KL1422G
		Yellow	KL1022Y			Yellow	KL1422Y
		Blue	KL1022B			Blue	KL1422B
		White	KL1022W			White	KL1422W
Ø12.0	24VAC/DC	Red	KL1212R	Ø16.0	24VAC/DC	Red	KL1612R
		Green	KL1212G			Green	KL1612G
		Yellow	KL1212Y			Yellow	KL1612Y
		Blue	KL1212B			Blue	KL1612B
Ø12.0	110VAC	White	KL1212W	Ø16.0	110VAC	White	KL1612W
		Red	KL1224R			Red	KL1624R
		Green	KL1224G			Green	KL1624G
		Yellow	KL1224Y			Yellow	KL1624Y
Ø12.0	220VAC	Blue	KL1224B	Ø16.0	220VAC	Blue	KL1624B
		White	KL1224W			White	KL1624W
		Red	KL1211R			Red	KL1611R
		Green	KL1211G			Green	KL1611G
Ø12.0	220VAC	Yellow	KL1211Y	Ø16.0	220VAC	Yellow	KL1611Y
		Blue	KL1211B			Blue	KL1611B
		White	KL1211W			White	KL1611W
		Red	KL1222R			Red	KL1622R
Ø12.0	220VAC	Green	KL1222G	Ø16.0	220VAC	Green	KL1622G
		Yellow	KL1222Y			Yellow	KL1622Y
		Blue	KL1222B			Blue	KL1622B
		White	KL1222W			White	KL1622W

Dimension

Unit : mm

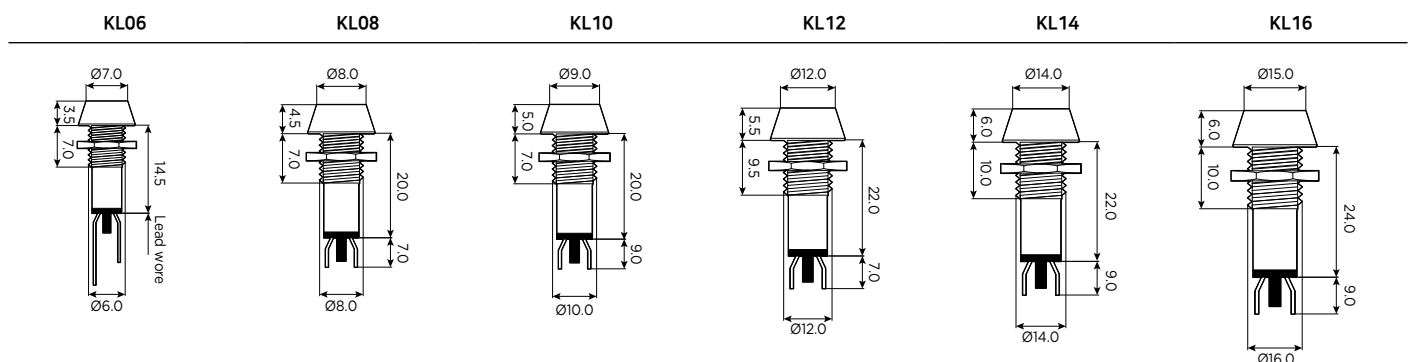

Rev. 2/14

Data subject may change without notice.

www.kacon.co.kr

Industrial Controls Catalog

II - IV - 59

KACOM